

BBSTORM Handprotector-Schalen / BBSTORM Handguard Shells

Die Artikelzuweisungen von diesem Produkt finden Sie auf unserer Website.
The application list for this product can be found on our website.

Montagehinweise

ACHTUNG: Die Montage dieses Produktes kann kompliziert sein und erfordert ein gutes technisches Verständnis. Wenn Sie unsicher sind, lassen Sie Montage und Wartung durch eine Fachwerkstatt durchführen. SW-MOTECH übernimmt keine Haftung für Schäden, die durch eine unsachgemäße Montage verursacht wurden.

ACHTUNG: Stellen Sie nach Montage der Handprotectoren sicher, dass alle Schalter- und Kontrolleinheiten, besonders der Gasgriff, Bremshebel, Notausschalter und die Kupplung, einwandfrei funktionieren und leicht zu bedienen sind. Achten Sie dabei auf die Übereinstimmung mit den OEM-Vorgaben. Fahren Sie nicht mit Ihrem Fahrzeug, wenn die Schalter- und Kontrolleinheiten nicht korrekt funktionieren oder zu bedienen sind. Stellen Sie des Weiteren sicher, dass der Lenker in beide Richtungen voll eingeschlagen werden kann. Überprüfen Sie regelmäßig (50 km) den festen Sitz aller Komponenten und Schrauben.

Technische Änderungen vorbehalten.
Irrtümer ausgenommen.

Mounting Instructions

ATTENTION: The assembly of this product can be complicated and requires a good technical understanding. If you are not sure of how to do this, have a specialty garage perform the mounting and service. SW-MOTECH accepts no liability for damages caused by improper installation.

ATTENTION: After the installation check all operations of all handlebar controls, specifically the throttle, front brake, kill switch and clutch, to ensure they are operating correctly and are in accordance with the OEM specifications. Do not ride the motorcycle if any controls are not operating correctly. Make sure the handlebar can fully turn in either direction. Check periodically (50 km) that all bolts are tight.

Subject to change. Not responsible for typos.

Powered by



1 Handprotectoren-Schale, LINKS
Handguard Shell, LEFT



SP1

Anzahl/Pcs. 1

3 Gewindefurchende Schraube
Self-Tapping Screw



M4 x 10 DIN 7970

Anzahl/Pcs. 2

2 Handprotectoren-Schale, RECHTS
Handguard Shell, RIGHT



SP1

Anzahl/Pcs. 1

4 Befestigungsbügel
Saddle



Storm-Saddle

Anzahl/Pcs. 2

5 Gewindefurchende Schraube
Self-Tapping Screw



M3,5 x 14 DIN 7981

Anzahl/Pcs. 4

SW-MOTECH GmbH & Co. KG
Ernteweg 8/10
35282 Rauschenberg
Germany

Tel. +49 (0) 64 25/8 16 8-00
Fax +49 (0) 64 25/8 16 8-10

info@sw-motech.com
www.sw-motech.com

Montage / Mounting

HINWEIS: Die Montage ist linksseitig dargestellt. Wiederholen Sie die Montage mit den entsprechenden Teilen am rechten Bügel analog zum linken Bügel.
Verschrauben Sie die Handprotektoren-Schalen (1) & (2) an den Bügeln (vor deren Montage am Fahrzeug), wie in der Zeichnung dargestellt.

ACHTUNG: Ziehen Sie die Schrauben vorsichtig handfest an (max. 2 Nm). Achten Sie unbedingt darauf, die Gewinde nicht zu überdrehen!

NOTE: Installation is shown for the left side. Repeat for right side with applicable parts.
Attach the handguard shells (1) & (2) to the backbones (before mounting the backbones to the vehicle), as shown in the drawing.

ATTENTION: Tighten the screws carefully by hand (max. 2 Nm). Do not overtighten the screws!

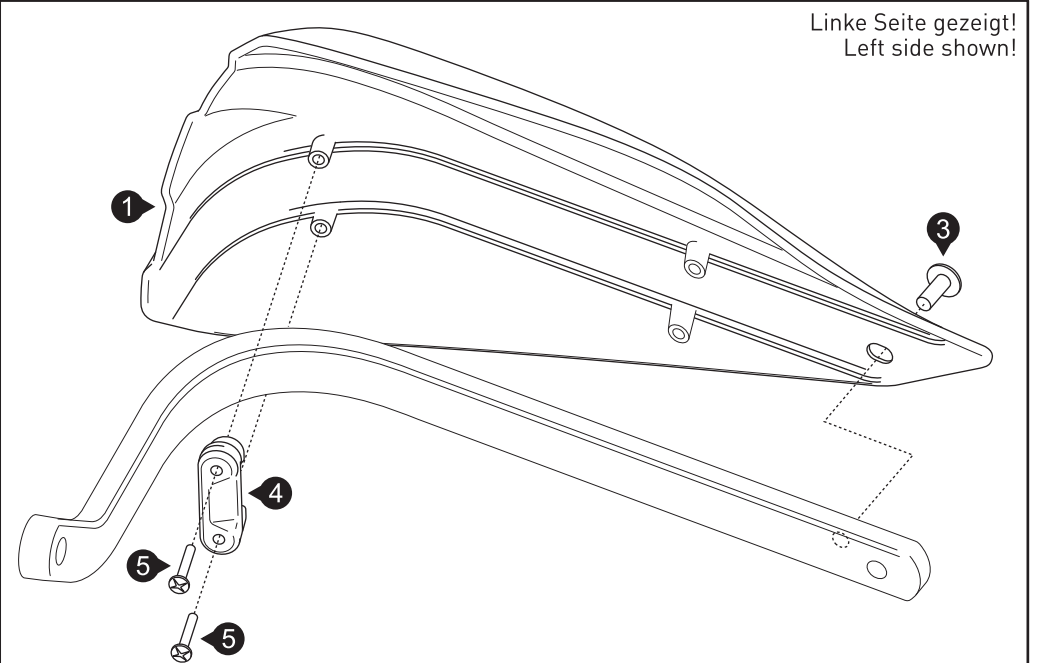

Barkbusters

www.barkbusters.net

**FITTING INSTRUCTIONS for
BMW G650X Challenge, Moto & Country**

Preparation

If bar end weights are installed they will need to be removed along with the threaded insert/nut to allow the handguard bar end fitting parts to be inserted. If the handlebar grips are not open at the end they will need to be cut open for the handguard to be fitted. Use a sharp knife to cut a hole in the end of each handgrip. On the right side the hole size should be neat and no smaller than the inside diameter of the throttle tube. Loosen the throttle assembly to move it outward about 20mm. Roll back the end of the grip and use a hacksaw to carefully cut off the end cap of the plastic throttle tube. Do not remove more than 3mm and take care not to cut the underlying handlebar. Before refitting, remove any burrs that could restrict throttle movement.

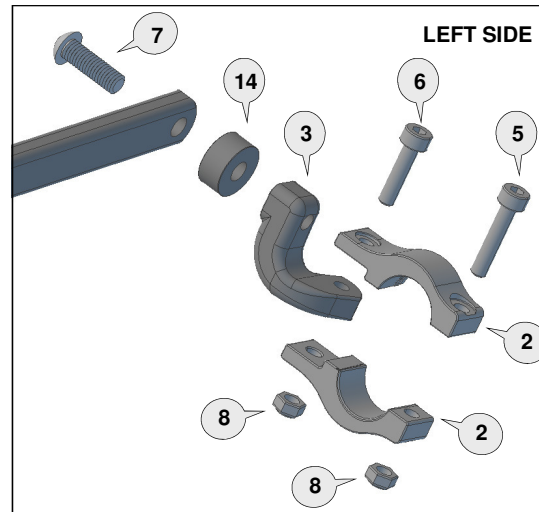
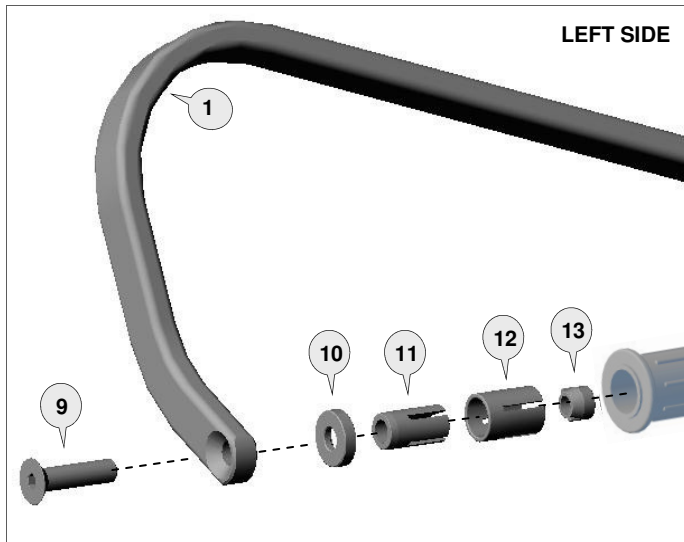

Important Fitting Procedure

Loosely assemble the clamp to the handlebar as per diagram. Attach the handguard backbone with applicable parts to the handlebar end and also to the clamp connector (3).

Position backbone so it is horizontal when viewed from the side and tighten bolt (9).

The clamp bolts must be tightened in the following order:

Tighten bolt (7) through the aluminium bar (1) and through spacer (14) to the clamp connector (3) of the clamp assembly.













Tighten bolt (6) to solidly lock the clamp connector (3) between the clamp saddles (2).

Tighten bolt (5) to secure the clamp assembly firmly to the handlebar.

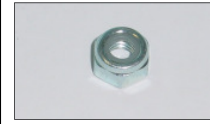
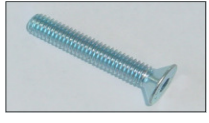
Note: The clamp is designed to allow the nut on bolt (6) to pull into the recessed hole. This eliminates the need for a wrench after the bolt starts to tighten.



Phone: +61 (0)2 4271 8244
Email: info@barkbusters.net

<p>1 Aluminium Bar</p>  <p>PN: BAR-V-041 Pcs. 1 Left & 1 Right</p>	<p>2 Clamp Saddle</p>  <p>PN: CS-00 Pcs. 4 pieces</p>	<p>3 Connector Left</p>  <p>PN: CP8-L Pcs. 1</p>	<p>4 Connector Right</p>  <p>PN: CP8-R Pcs. 1</p>	<p>5 Socket Head Bolt 30mm</p>  <p>PN: M6x30SHCSZP Pcs. 2</p>	<p>6 Socket Head Bolt 25mm</p>  <p>PN: M6x25SHCSZP Pcs. 2</p>	<p>7 Button Head Bolt 35mm</p>  <p>PN: M8x35BHCSZP Pcs. 2</p>	<p>8 Nylock Nut 6mm</p>  <p>PN: M6LN Pcs. 4</p>
<p>9 Flat Head Bolt 45mm</p>  <p>PN: M8x45FHCSZP Pcs. 2</p>	<p>10 Collar</p>  <p>PN: BBEC5M Pcs. 2</p>	<p>11 Expander</p>  <p>PN: BBE14A Pcs. 2</p>	<p>12 Collet</p>  <p>PN: COLLET14-16 Pcs. 2</p>	<p>13 Taper Nut</p>  <p>PN: NUT12 Pcs. 2</p>	<p>14 Spacer 10mm</p>  <p>PN: BSSRT10 Pcs. 2</p>		

Recommended Torque Settings	
M6	10 Nm (7.4 lbf ft)
M8	20 Nm (14.8 lbf ft)

CAUTION:

Installation of the handguard is safety-relevant work and can be complicated. We recommend the installation be performed by a motorcycle service technician. Rideworx accepts no liability for damages caused by improper mounting. All screws, bolts and nuts, including all replacement hardware provided by Rideworx, should be tightened to the torque specified in the below table. After the first 50km of riding check all screws, bolts and nuts are tightened to the correct torque. We recommend a medium strength liquid thread lock product on all fasteners.

WARNING:

It is important there is a working clearance (approx 3mm) between the throttle grip end and the handguard to ensure a free closing throttle. Check operation of all handlebar controls, specifically the throttle, front brake, kill switch and clutch to ensure they are operating correctly and are in accordance with the OEM specifications. Do not ride the motorcycle if any controls are not operating correctly. Check periodically that all bolts are tight.

Disclaimer:

Rideworx inspects all products prior to packaging and strives toward improving its products. Our guarantee is limited to the replacement of defective products. This limited guarantee is in lieu of all other guarantees or warranties implied or expressed. Buyer assumes all risk for any and all damage caused to him/herself, a third party and/or property by virtue of failure of this product. We make no warranty as to products distributed by Rideworx, expressed or implied from our suppliers or third party vendors. This includes, without limitation, any warranties or merchantability and fitness for a particular purpose. All products are offered and designed for use with standard machines. Rideworx makes no claims as to the products effectiveness on modified machines. Rideworx is the sole determiner of abuse, misuse, installation errors and modifications. We assume no liability for any errors in listings, specifications, part numbers, prices or model applications. We reserve the right to change specifications, product descriptions, product quality, pricing and application at any time without notice and without further obligation. These handguards are not designed to prevent injury in the event of an accident or crash. Ensure all controls are free of the handguards each time you ride. Failure to follow the instructions or heed this warning could lead to loss of control of your motorcycle and/or accident, injury or death. By installing and/or using a Rideworx product, you hereby accept and understand these stated terms and conditions and have followed all instructional steps.



Phone: +61 (0)2 4271 8244
Email: info@barkbusters.net
Web: www.barkbusters.net

Barkbusters