

SHAD

YAMAHA X-MAX 300i '17 / TRICITY 300 '20

KIT RESPALDO YOXM37RV

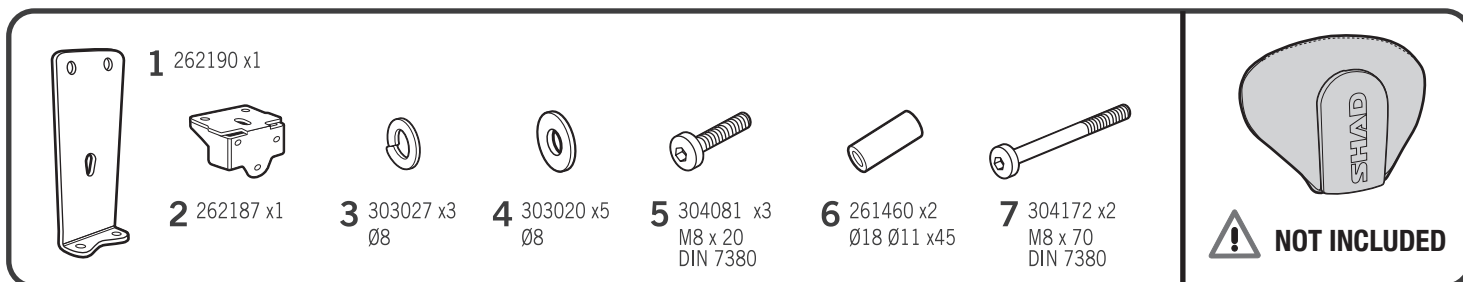

! WARNING!

(GB) Do not fully tighten the screws until it is ensured that the KIT is correctly attached and aligned.

(E) No apretar los tornillos del todo hasta asegurarse que el KIT está correctamente colocado y alineado.

(D) Ziehen Sie die Schrauben nicht ganz fest, bevor Sie sich nicht vergewissert haben, daß der Bausatz korrekt eingestellt und ausgerichtet ist.

(I) Non stringere del tutto le viti fin tanto non si è sicuri che il kit è collocato correttamente e allineato.

(F) Ne pas serrer les vis avant d'être sûr que le KIT soit correctement positionné et ajusté.

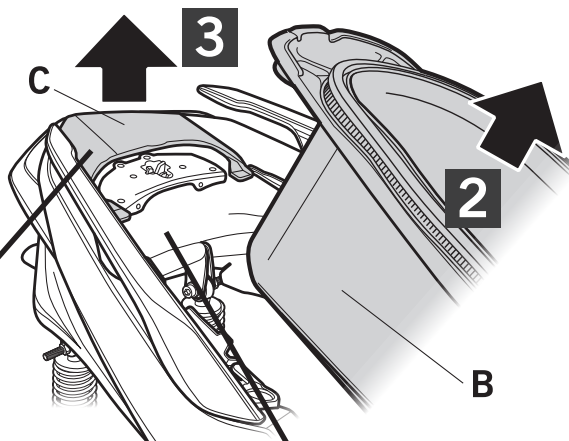
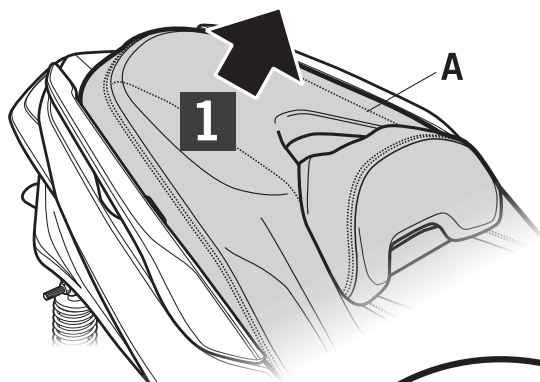

X-MAX 300i

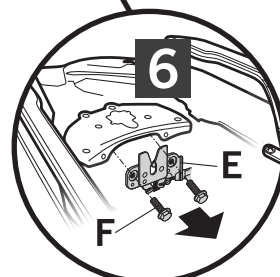
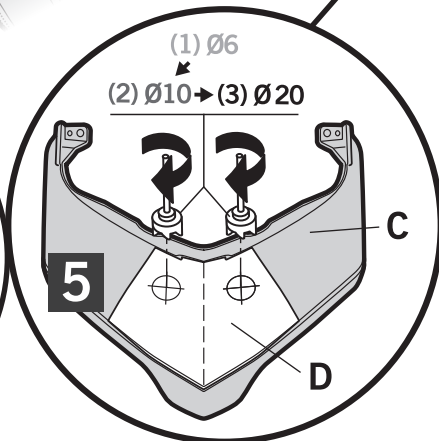
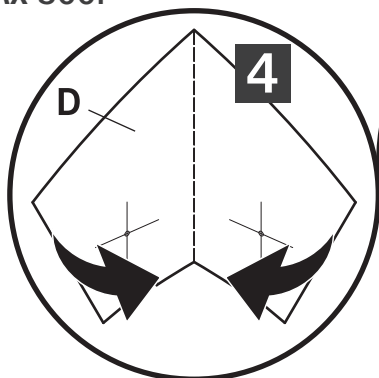

TRICITY 300

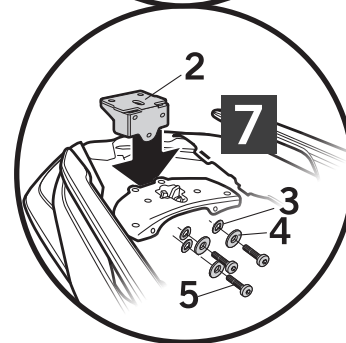
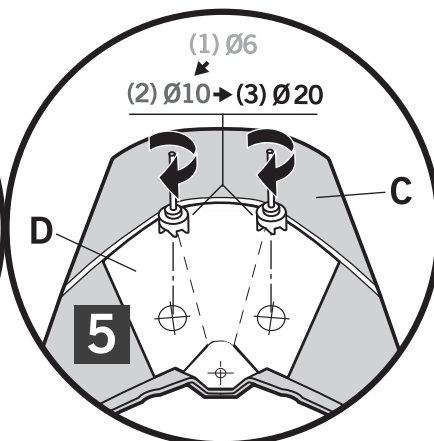
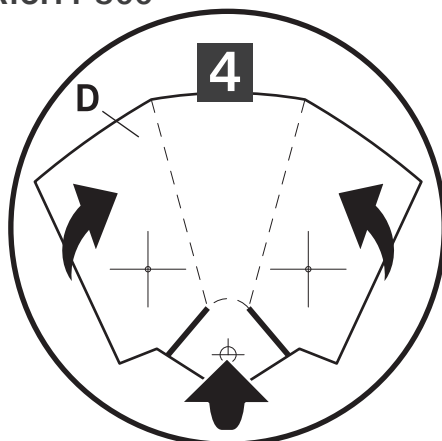

IMPORTANT: Based on European models. For compatibility with models in other continents, check www.shad.es

SHAD

YAMAHA X-MAX 300i '17 TRICITY 300 '20

KIT RESPALDO YOXM37RV

