

1 The Eastgate Office Centre  
Eastgate Road  
Bristol BS5 6XX  
United Kingdom



Switchboard +44 (0) 117 9515151  
Main Fax: +44 (0) 117 9524103  
E-mail: general@vca.gov.uk  
Web Site: www.vca.gov.uk

THE UNITED KINGDOM VEHICLE APPROVAL AUTHORITY

Rev 5/91



COMMUNICATION CONCERNING THE APPROVAL GRANTED OF A  
TYPE OF DEVICE PURSUANT TO REGULATION NO 50  
(*Motorcycle Lamps and Illuminating Devices*)

Approval No: 000122

1. Trade name or mark of the device:

Trade Mark:   
Trade Name: ST

2. Manufacturer's name for the type of device:  
ST-070-1, ST-070A, ST-070A-1, ST-070A-2, ST-070A-3, ST-070A-4, ST-070A-5 and ST-070A-6
3. Manufacturer's name and address:

Yuan Jeou Industrial Company Limited  
199, Alley 125  
Lane 318  
Sec. 2 An-Ho Road  
Tainan City  
Taiwan  
Republic Of China



4. If applicable, name and address of the manufacturer's representative: Not applicable
5. Submitted for approval on: 17 December 2001
6. Technical service responsible for conducting approval tests: Vehicle Certification Agency
7. Date of report issued by that service: 1 April 2002



8. Number of report issued by that service: EAB007913

9. Concise description:  
By category of lamp: 11 and 12

Colour of light emitted: Amber

Number and category of filament lamp(s): 1 x H21W

10. Position of the approval mark: On the lens

11. Reason(s) for extension (if applicable): Not applicable

12. Approval: GRANTED

13. Place: BRISTOL

14. Date: 3 APRIL 2002

15. Signature: *Patricia Bolton*

p.p. P F NICHOLL



16. The list of documents deposited with the Administrative Service which has granted approval is annexed to this communication and may be obtained on request.

EAB007913

# Yuan Jeou Industrial Co., Ltd.

## 沅久實業股份有限公司

### Information Document

for Initial application to ECE Homologation  
of Model Number ST-070 serious

items	Details		Initial	Extension-	00	Remark
1.	VCA					
1.1	Job Number		EAB007913			
1.2	Approval Number		00 0122			
2.	Manufacturer					
2.1	Name		Yuan Jeou Industrial Co., Ltd.			
2.2	Address		199, Alley 125, lane 318, Sec. 2, An-Ho Road, Tainan City, Taiwan, Republic of China			
2.3	Trade name or mark		ST			
3.	Product					
3.1	Model Number		ST-070 serious			
3.2	Intended functions	Charteristic				
3.2.1	Front & Rear Direction Indicator (Reg. 50)	Category	11 & 12			
		Bulb	H21W 12V 21W			
		Color of light	Amber			
		Color of lens	Amber			
4.	Drawings		ST-070			



Note: 1. This drawing is applicable to the right hand side and the left hand side is symmetrical.  
 2. The difference between ST-070A and ST-070-1 are the outermost housing and length.

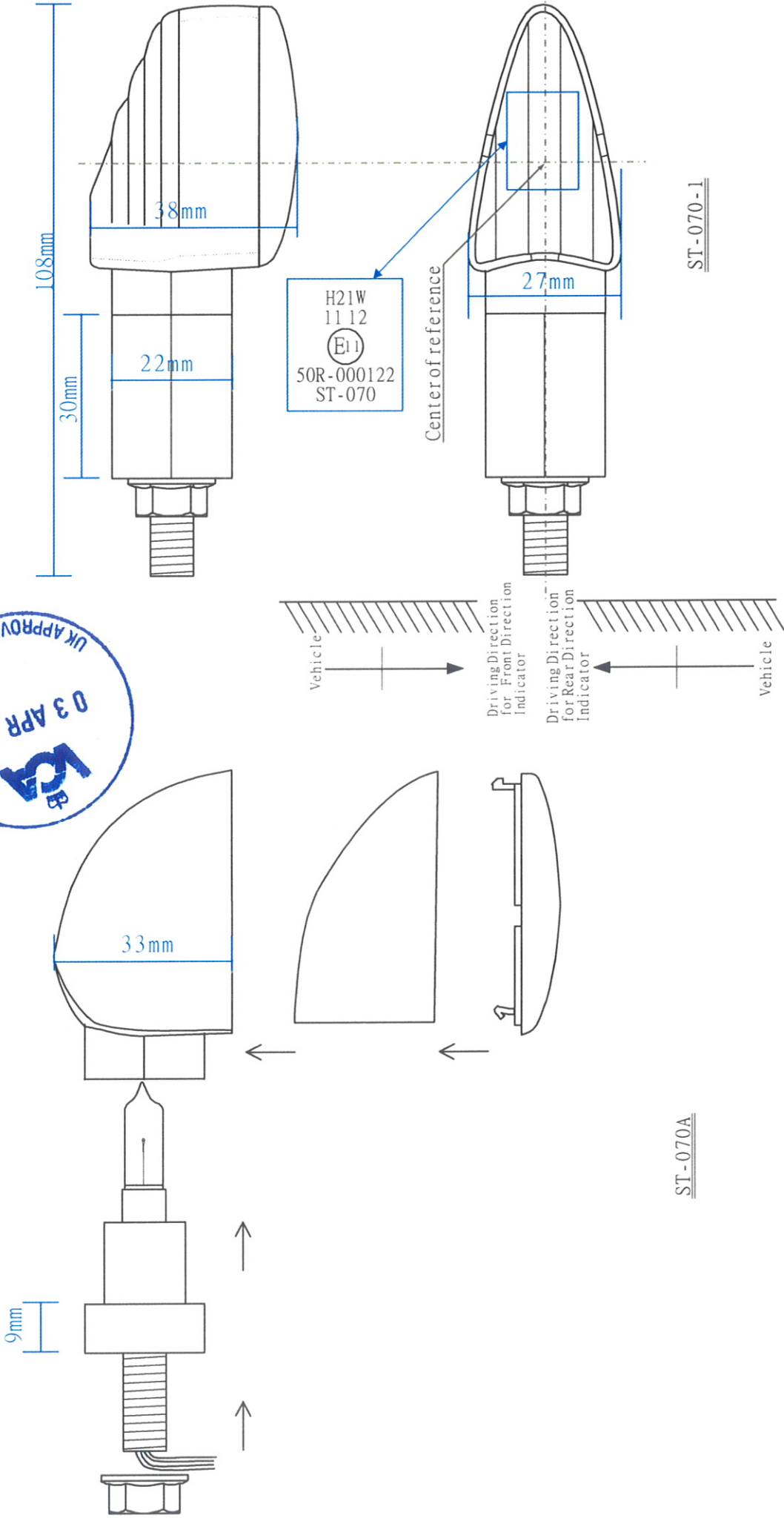

ST-070A

ST-070-1

Model No.	ST-070-1&070A	Drawing No.	ST-070
Function	Front & Rear Direction Indicator		

沅久實業股份有限公司  
 Yuan Jeou Industrial Co., Ltd.

# YUAN JEOU INDUSTRIAL CO.,LTD.

## ST-070 serious Direction Indicator

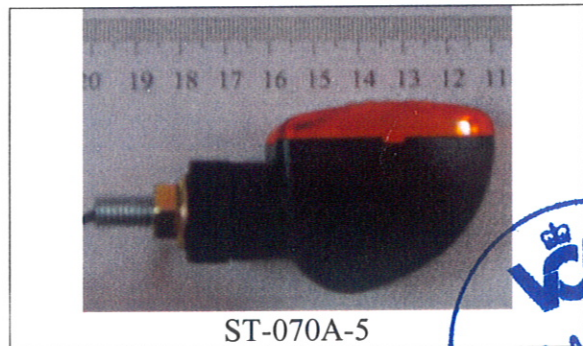
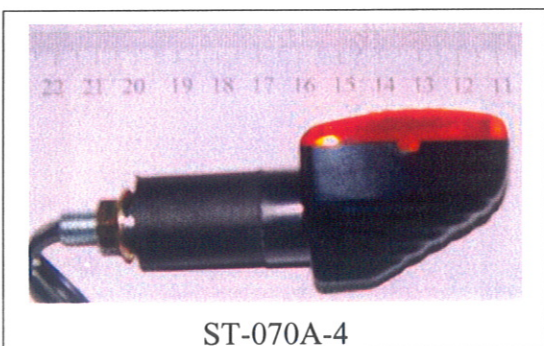
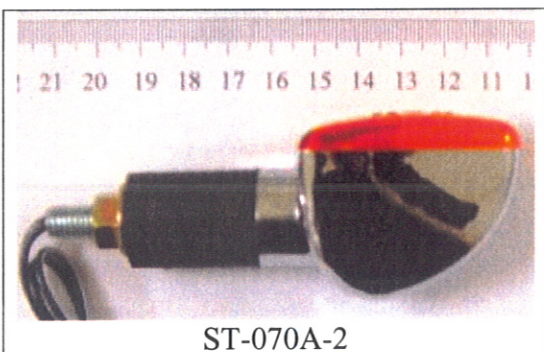
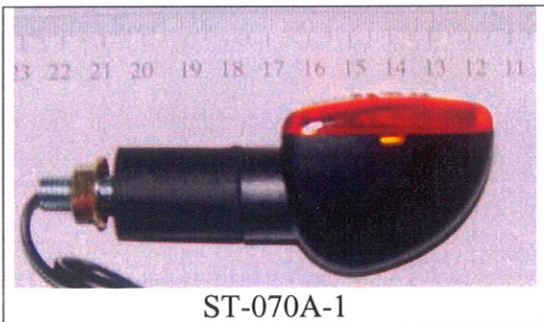
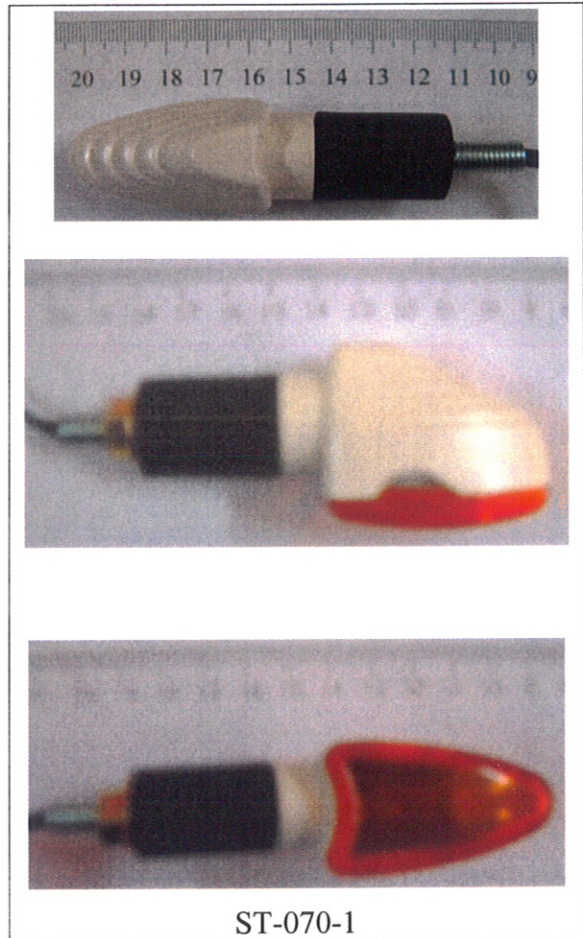
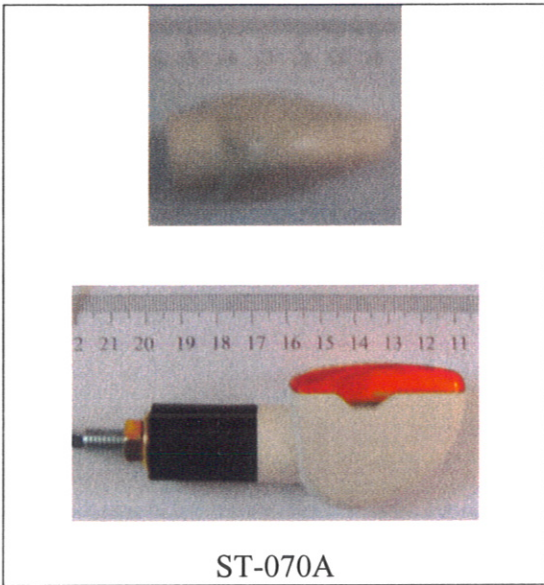

# YUAN JEOU INDUSTRIAL CO.,LTD.

## ST-070 serious Direction Indicator

