

Hauptständer

TRIUMPH Tiger 800

Art.-Nr.: 505.7505 00 01 schwarz

Montage

Der Bausatz umfaßt die folgenden Teile:

St	Bestellnr.	Bezeichnung
1x	700007606	Hauptständer
1x	700007607	Anschlaghalter
1x	700007608	Feder (spezial)
1x	700007611	Federverlängerung
1x	275.001	Anschlaggummi
2x	HS705012	Gewindebuchsen M10
1x	150.864	Inbusschraube M10x25
1x	150.728	Aludistanz Ø13xØ7x7mm
1x	151.291	Aludistanz Ø25xØ11x5mm
2x	150.868	Inbusschrauben M10x45
1x	151.172	Stahldistanz Ø10xØ7x7mm
1x	150.938	Linsenkopfschraube M8x20
1x	150.830	Sechskantschraube M6x25
4x	150.811	U-Scheiben Ø10,5
1x	150.986	Karoseriescheibe Ø6,4xØ18
1x	150.810	U-Scheibe Ø8,4
1x	150.801	selbstsichernde Mutter M10

Seitenkoffer
Topcases
Gepäckträger
Lock it System
Softbags
Aluminiumkoffer
Lederkoffer
Schutzbügel
Hauptständer
Chopper-Parts
Quad-Parts
Accessoires



Abbildung zeigt als weiteres Zubehör die Motorschutzplatte

Bitte kontrollieren Sie nun die Funktionalität Ihres Hauptständers und überprüfen Sie die Festigkeit aller montierten Teile. Schrauben mit flüssiger Schrauben-Sicherung einkleben.

Nehmen Sie das Motorrad vom Hauptständer und kontrollieren Sie den Hauptständer nach der Montage auf das selbstständige Hochklappen in die obere Endlage.

Prüfen Sie nach 50 km alle Verbindungen auf festen Sitz.

Die Kurvenfreiheit kann durch einen Hauptständer eingeschränkt werden.

Allgemein:

Alle vom Motorrad gelösten Schrauben sind gemäß Herstellerangaben wieder zu montieren, oder mit von HEPSCO & BECKER gelieferten Schrauben zu ersetzen. Falls nicht anderweitig definiert, diese Schrauben mit folgenden Werten anziehen:

M 6 - 9,6 Nm M 8 - 23 Nm M 10 - 46 Nm

Gegebenfalls die Schraubverbindungen mit Schraubensicherung zusätzlich sichern.



Hepco & Becker GmbH
An der Steinmauer 6

D-66955 Pirmasens

Tel.: 06331 - 1453 - 100

Fax: 06331 - 1453 - 120

eMail: vertrieb@hepco-becker.de

www.hepco-becker.de

Hauptständer

TRIUMPH Tiger 800

Art.-Nr.: 505.7505 00 01 schwarz

Seitenkoffer

Topcases

Gepäckträger

Lock it System

Softbags

Aluminiumkoffer

Lederkoffer

Schutzbügel

Hauptständer

Chopper-Parts

Quad-Parts

Accessoires



Montage

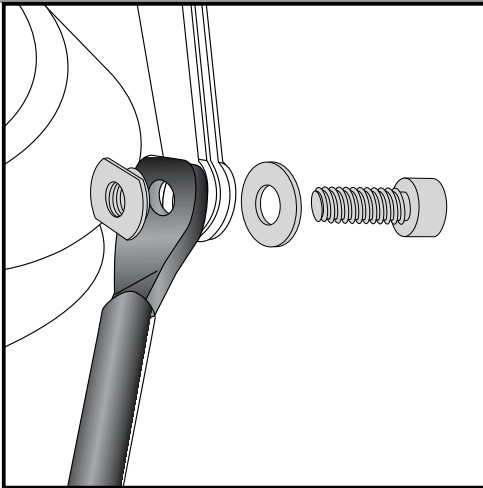

- 1** Befestigung des Hauptständers rechts:
Unterhalb der Fußraste an der freien Bohrung mit der Inbusschraube M10x25 sowie der U-Scheibe Ø10,5.
Von hinten mit der Gewindebuchse M10 verschrauben.
Drehflächen zuvor einfetten.
Sicherungsmittel verwenden.

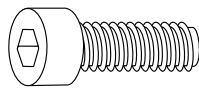

1x

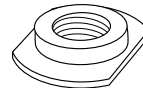

1x

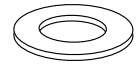

1x

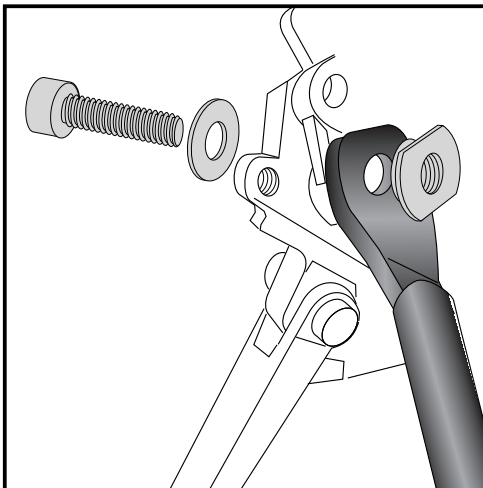

- 2** Befestigung des Hauptständers links:
Die Originalschraube der unteren Verschraubung des Seitenständers demontieren (entfällt).
Die Befestigung des Hauptständers erfolgt an der nun freien Bohrung mit der Inbusschraube M10x45 sowie der U-Scheibe Ø10,5.
Von hinten mit der Gewindebuchse M10 verschrauben.
Drehflächen zuvor einfetten.
Sicherungsmittel verwenden.

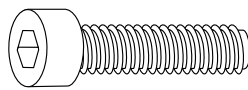

1x



1x

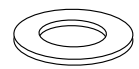

1x

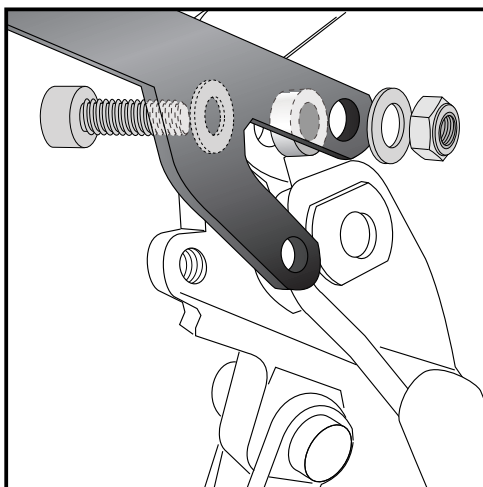

- 3** Befestigung des Anschlaghalters oben:
Dieser wird links am Motorrad montiert. Die obere Schraube des Seitenständers demontieren (entfällt) Den Halter von der Rückseite her montieren, hierzu die Inbusschraube M10x45 sowie die U-Scheibe Ø10,5 verwenden. Von hinten mit der U-Scheibe Ø10,5 sowie selbstsichernder Mutter M10 verschrauben.
Zwischen Halter und Rahmen die Aludistanz Ø25xØ11x5mm fügen.

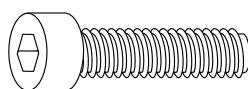

1x

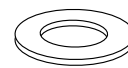

2x

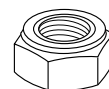

1x

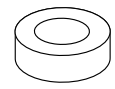

1x

Hauptständer

TRIUMPH Tiger 800

Art.-Nr.: 505.7505 00 01 schwarz

Seitenkoffer

Topcases

Gepäckträger

Lock it System

Softbags

Aluminiumkoffer

Lederkoffer

Schutzbügel

Hauptständer

Chopper-Parts

Quad-Parts

Accessoires



Montage

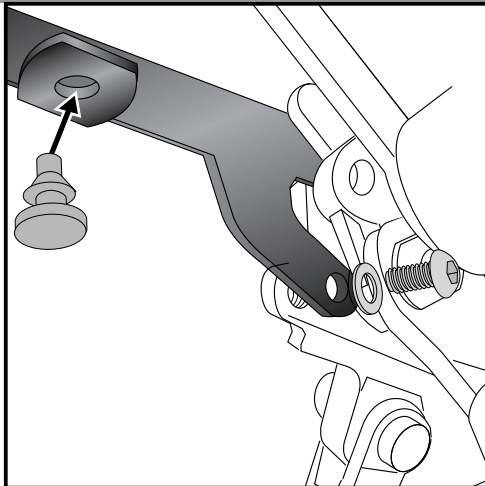

4

Befestigung des Anschlaghalters unten:

An der freien Gewindebohrung am Halter des Seitenständers. Hierzu die Linsenkopfschraube M8x20 sowie die U-Scheibe Ø8,4 verwenden. Diese wird von hinten montiert. Anschlaggummi einsetzen.

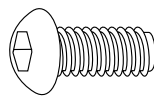

1x



1x

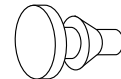

1x

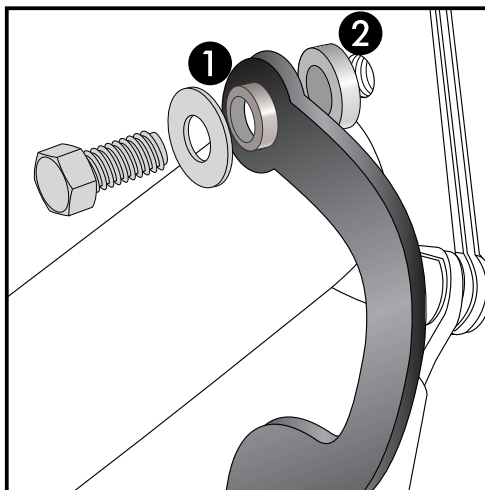

5

Befestigung der Federverlängerung rechts:

an der Rückseite des Rahmenauslegers hinter dem Bremshebel an der freien Gewindebohrung mit der Sechskantschraube M6x25 sowie der Karoseriescheibe Ø6,4 x 18 verschrauben.

In die Bohrung der Federverlängerung die Stahldistanz Ø10xØ7x7mm stecken. ①

Zwischen Stahldistanz und Rahmen die Aludistanz Ø13xØ7x7mm fügen. ② Vorher Flächen einfetten.

Nach dem Festziehen prüfen, ob sich die Federverlängerung frei drehen lässt.

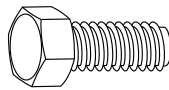

1x

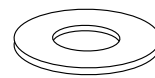

1x



1x

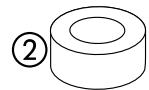

1x

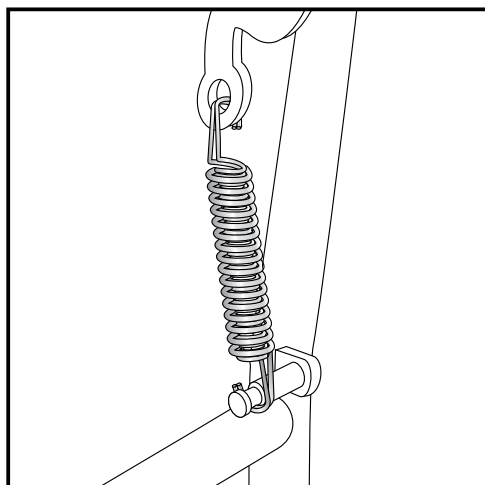

6

Befestigung der Feder:

Die Feder wird oben an der Federverlängerung eingehängt.

Dann die Feder am Bolzen des Hauptständers einhängen.

Wir empfehlen hierfür das als Zubehör erhältliche Federmontage-Werkzeug (Art.-Nr.: 700.030)

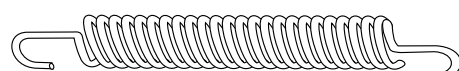

1x

Center stand

TRIUMPH Tiger 800

Item-No.: 505.7505 00 01 black

Side cases

Top cases

luggage frames

Lock it system

Softbags

Aluminium luggage

Leather luggage

Protection bars

Center stands

Chopper parts

Quad parts

Accessories



Assembling instructions

The kit includes the following parts:

quant	item no.	description
1x	700007606	center stand
1x	700007607	stop adapter
1x	700007608	spring(special)
1x	700007611	spring adapter
1x	275.001	rubber
2x	HS705012	threaded socket M10
1x	150.864	allen screw M10x25
1x	150.728	alu spacer Ø13xØ7x7mm
1x	151.291	alu spacer Ø25xØ11x5mm
2x	150.868	allen screw M10x45
1x	151.172	steel spacer Ø10xØ7x7mm
1x	150.938	filister head screw M8x20
1x	150.830	hexagon bolt M6x25
4x	150.811	washer Ø10,5
1x	150.986	body washer Ø6,4xØ18
1x	150.810	washer Ø8,4
1x	150.801	self lock nut M10

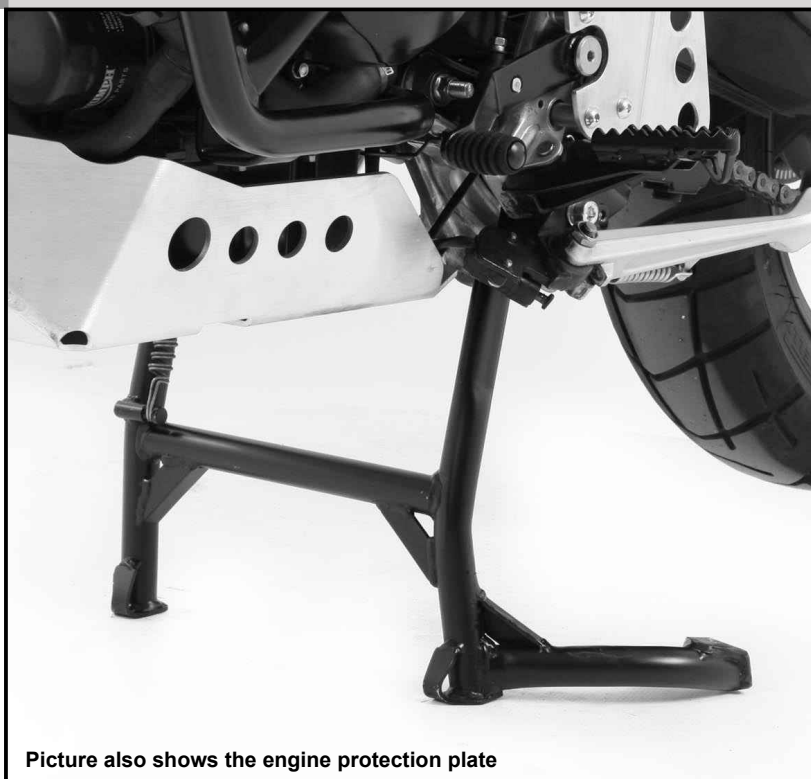

Picture also shows the engine protection plate

Please check now the function of your centre stand and control all assembled screw connections for tightness! Please notice our enclosed service information. All screws, bolts and nuts should be checked after driving the first 50 km to ensure that all are tightened to the proper torque. Liquid thread-locker (i.e., „Locktite“) should be used to secure all screws, bolts, and nuts.

General:

Centre stand cornering clearance:

HEPCO & BECKER centerstands are carefully designed and tested to eliminate reductions in cornering clearance and ground clearance under most driving conditions on an unmodified stock motorcycle, and are certified to be compliant with European ABE safety standards. Use of any centrestand may reduce cornering clearance or ground clearance under extreme driving situations. HEPCO & BECKER products should be installed by a qualified, experienced motorcycle technician. If you are unsure of your ability to properly install a product, please have the product installed by your local motorcycle dealer.

HEPCO & BECKER takes no responsibility for damages caused by improper installation.

All screws, bolts, and nuts, including all replacement hardware provided by HEPCO & BECKER, should be tightened to the torque specified in the OEM maintenance manual for your motorcycle.

The side-sway-behavior may be restricted by the centre stand.



Hepco & Becker GmbH
An der Steinmauer 6
D-66955 Pirmasens
Germany

Tel.: +49 6331 - 1453 - 100
Fax: +49 6331 - 1453 - 120
eMail: vertrieb@hepco-becker.de
www.hepco-becker.de

Center stand

TRIUMPH Tiger 800

Item-No.: 505.7505 00 01 black

Side cases

Top cases

Luggage frames

Lock it system

Softbags

Aluminium luggage

Leather luggage

Protection bars

Center stands

Chopper parts

Quad parts

Accessories



Assembling instructions

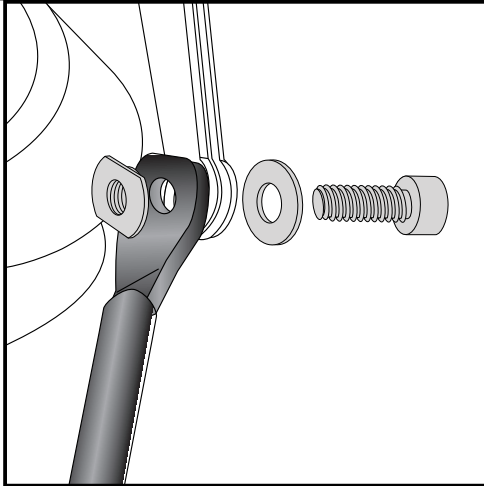

- 1** Fastening of the center stand right: _____
under the footrest at the free boring with allen screw M10x25 with washer Ø10,5.
At the inner side stick the threaded sockets M10 into the boring in the center stand.
Grease the surfaces before mounting.
Use liquid thread-locker.

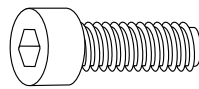

1x

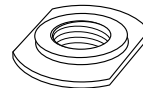

1x

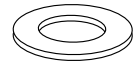

1x

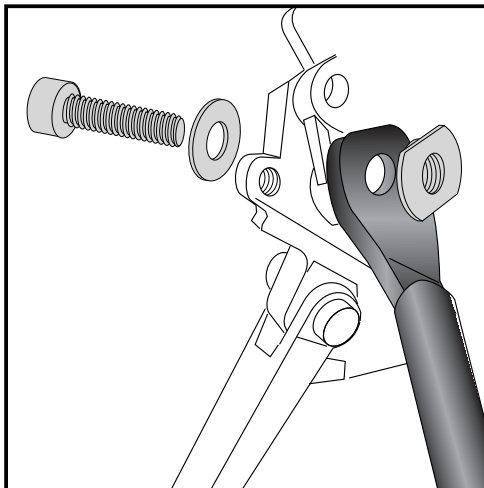

- 2** Fastening of the center stand left: _____
at the lower bolting of the side stand - original screw is obsolete.
Use allen screw M10x45 with washer Ø10,5.
At the inner side stick the threaded sockets M10 into the boring in the center stand.
Grease the surfaces before mounting.
Use liquid thread-locker.

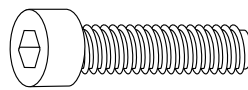

1x



1x

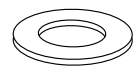

1x

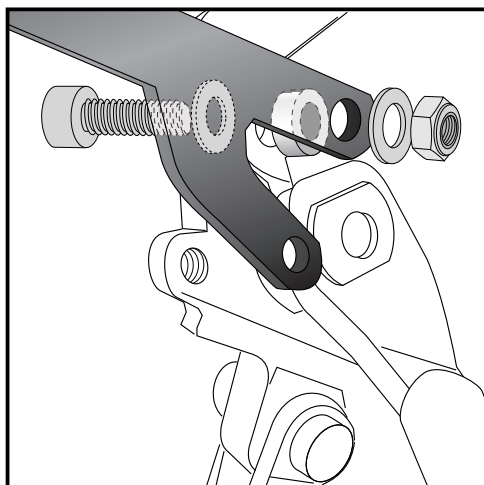

- 3** Fastening of the stop adapter top left: _____
at the top bolting of the side stand - original screw is obsolete.
Use allen screw M10x45 with washer Ø10,5.
At the inner side use washer Ø10,5 with self lock nut M10.
Sandwich alu spacer Ø25xØ11x5mm between adapter and frame.

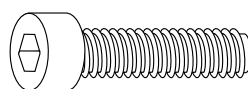

1x

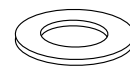

2x

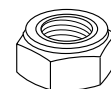

1x

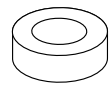

1x

Luggage ideas.

Center stand

TRIUMPH Tiger 800

Item-No.: 505.7505 00 01 black

Side cases

Top cases

Luggage frames

Lock it system

Softbags

Aluminium luggage

Leather luggage

Protection bars

Center stands

Chopper parts

Quad parts

Accessories



Assembling instructions

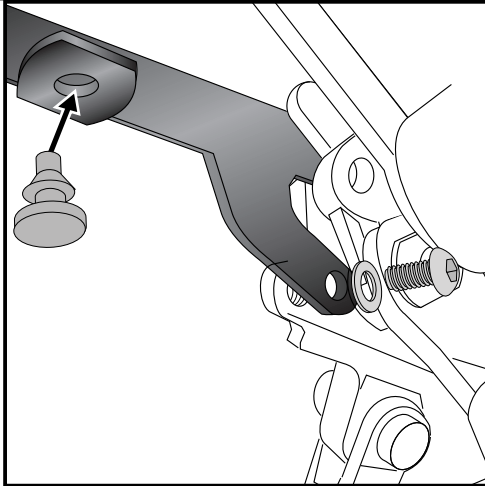

4

Fastening of the stop adapter bottom:

at the free threaded bolting of the side stand from the inner side.
Use filister head screw screw M8x20 with washers Ø8,4.

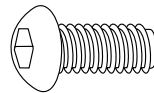

1x



1x

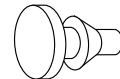

1x

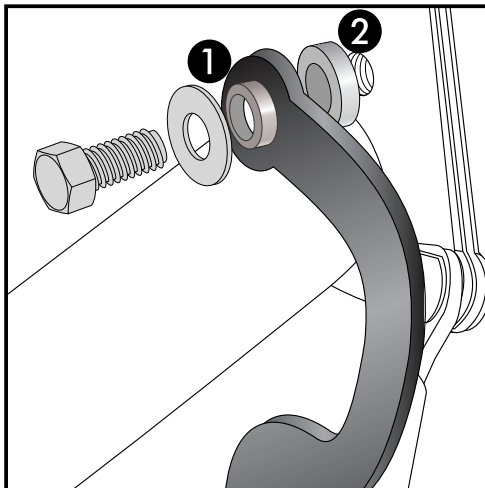

5

Fastening of the spring adapter right:

at the free threaded bolting on the inner side of the frame with hexagon bolt M6x25 with body washer Ø6,4 verschrauben.

Put steel spacer Ø10xØ7x7mm ① into the boring of the spring adapter.

Sandwich alu spacer Ø13xØ7x7mm ② between adapter and frame.

Grease the surfaces before mounting.

Tighten the screws only to the extent that the spring adapter is still rotating free.

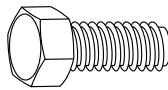

1x

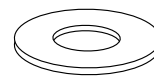

1x



1x



1x

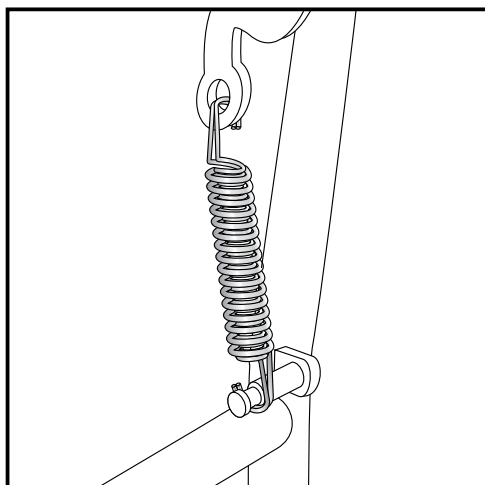

6

Fastening of the spring:

The springs will be fixed at the spring adapter and at the pin of the center stand.

We recommend our spring-mounting kit (item.-No.: 700.030)

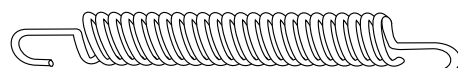

1x

Luggage ideas.

3